

RF MOSFET Power Transistor, 40W, 28V

2 - 175 MHz

DU2840S

V2.00

Features

- N-Channel Enhancement Mode Device
- DMOS Structure
- Lower Capacitances for Broadband Operation
- High Saturated Output Power
- Lower Noise Figure Than Bipolar Devices

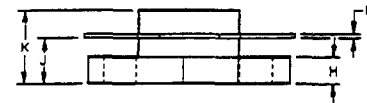
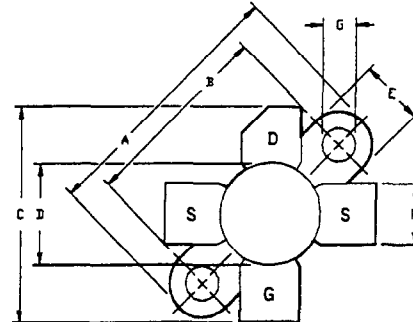

Absolute Maximum Ratings at 25°C

Parameter	Symbol	Rating	Units
Drain-Source Voltage	V_{DS}	65	V
Gate-Source Voltage	V_{GS}	20	V
Drain-Source Current	I_{DS}	8	A
Power Dissipation	P_D	125	W
Junction Temperature	T_J	200	°C
Storage Temperature	T_{STG}	-55 to +150	°C
Thermal Resistance	θ_{JC}	1.4	°C/W

LETTER DIM	MILLIMETERS		INCHES	
	MIN	MAX	MIN	MAX
A	24.64	24.89	.970	.980
B	18.29	18.54	.720	.730
C	20.07	20.83	.790	.820
D	9.47	9.73	.373	.383
E	6.22	6.48	.245	.255
F	5.64	5.79	.222	.228
G	2.92	3.30	.115	.130
H	2.29	2.67	.090	.105
J	4.04	4.55	.159	.179
K	6.58	7.39	.259	.291
L	.10	.15	.004	.006

Electrical Characteristics at 25°C

Parameter	Symbol	Min	Max	Units	Test Conditions
Drain-Source Breakdown Voltage	BV_{DSS}	65	-	V	$V_{GS}=0.0\text{ V}, I_{DS}=10.0\text{ mA}$
Drain-Source Leakage Current	I_{DSS}	-	2.0	mA	$V_{DS}=28.0\text{ V}, V_{GS}=0.0\text{ V}$
Gate-Source Leakage Current	I_{GSS}	-	2.0	μA	$V_{GS}=20.0\text{ V}, V_{DS}=0.0\text{ V}$
Gate Threshold Voltage	$V_{GS(TH)}$	2.0	6.0	V	$V_{DS}=10.0\text{ V}, I_{DS}=200.0\text{ mA}$
Forward Transconductance	G_M	1	-	S	$V_{DS}=10.0\text{ V}, I_{DS}=2000.0\text{ mA}, \Delta V_{GS}=1.0\text{ V}, 80\text{ }\mu\text{s Pulse}$
Input Capacitance	C_{ISS}	-	90	pF	$V_{DS}=28.0\text{ V}, F=1.0\text{ MHz}$
Output Capacitance	C_{OSS}	-	80	pF	$V_{DS}=28.0\text{ V}, F=1.0\text{ MHz}$
Reverse Capacitance	C_{RSS}	-	16	pF	$V_{DS}=28.0\text{ V}, F=1.0\text{ MHz}$
Power Gain	G_P	13	-	dB	$V_{DD}=28.0\text{ V}, I_{DQ}=200\text{ mA}, P_{OUT}=40.0\text{ W}, F=175\text{ MHz}$
Drain Efficiency	η_D	60	-	%	$V_{DD}=28.0\text{ V}, I_{DQ}=200\text{ mA}, P_{OUT}=40.0\text{ W}, F=175\text{ MHz}$
Load Mismatch Tolerance	VSWR-T	-	30:1	-	$V_{DD}=28.0\text{ V}, I_{DQ}=200\text{ mA}, P_{OUT}=40.0\text{ W}, F=175\text{ MHz}$

Specifications Subject to Change Without Notice.

M/A-COM, Inc.

North America: Tel. (800) 366-2266
Fax (800) 618-8883

Asia/Pacific: Tel. +81 (03) 3226-1671
Fax +81 (03) 3226-1451

Europe: Tel. +44 (1344) 869 595
Fax +44 (1344) 300 020

Typical Broadband Performance Curves

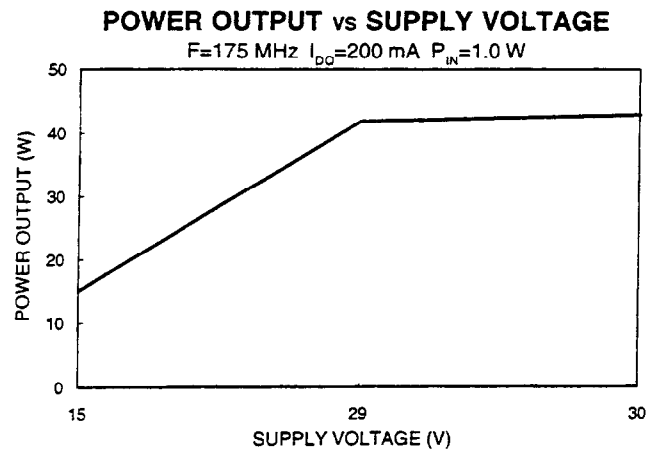
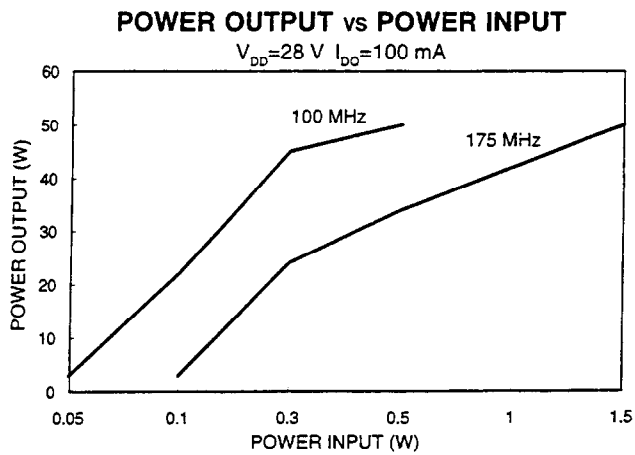
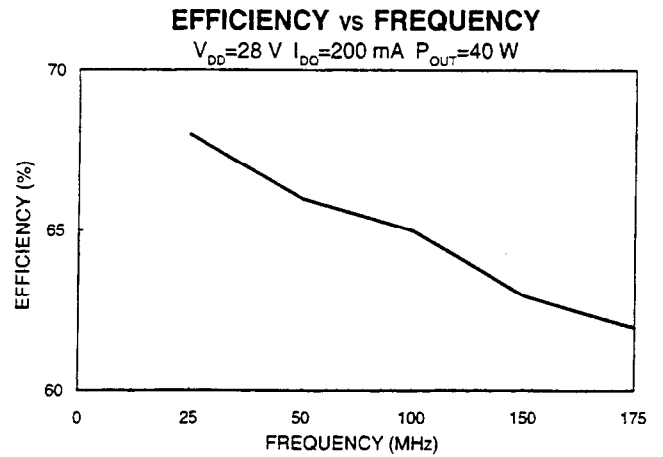
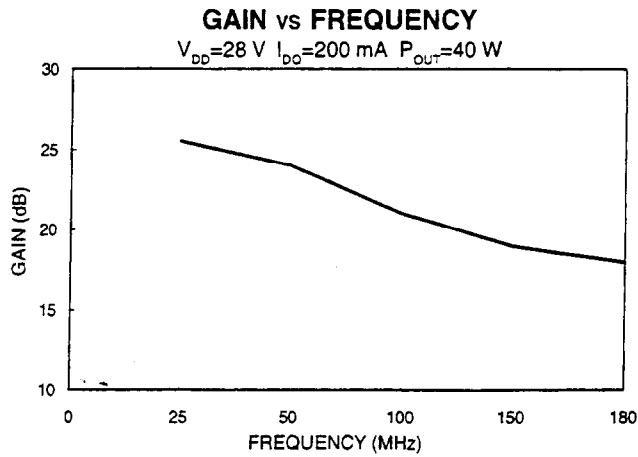

Specifications Subject to Change Without Notice.

M/A-COM, Inc.

North America: Tel. (800) 366-2266
 Fax (800) 618-8883

Asia/Pacific: Tel. +81 (03) 3226-1671
 Fax +81 (03) 3226-1451

Europe: Tel. +44 (1344) 869 595
 Fax +44 (1344) 300 020

Typical Device Impedance

Frequency (MHz)	Z _{IN} (OHMS)	Z _{LOAD} (OHMS)
30	12.0 - j 6.8	6.5 - j 1.5
50	10.0 - j 6.5	6.0 - j 1.8
100	6.0 - j 5.5	5.5 - j 1.8
200	1.1 - j 3.0	3.5 - j 1.8

V_{DD}=28 V, I_{DD}=200 mA, P_{OUT}=40 Watts

Z_{IN} is the series equivalent input impedance of the device from gate to source.

Z_{LOAD} is the series equivalent load impedance as measured from drain to ground.

RF Test Fixture

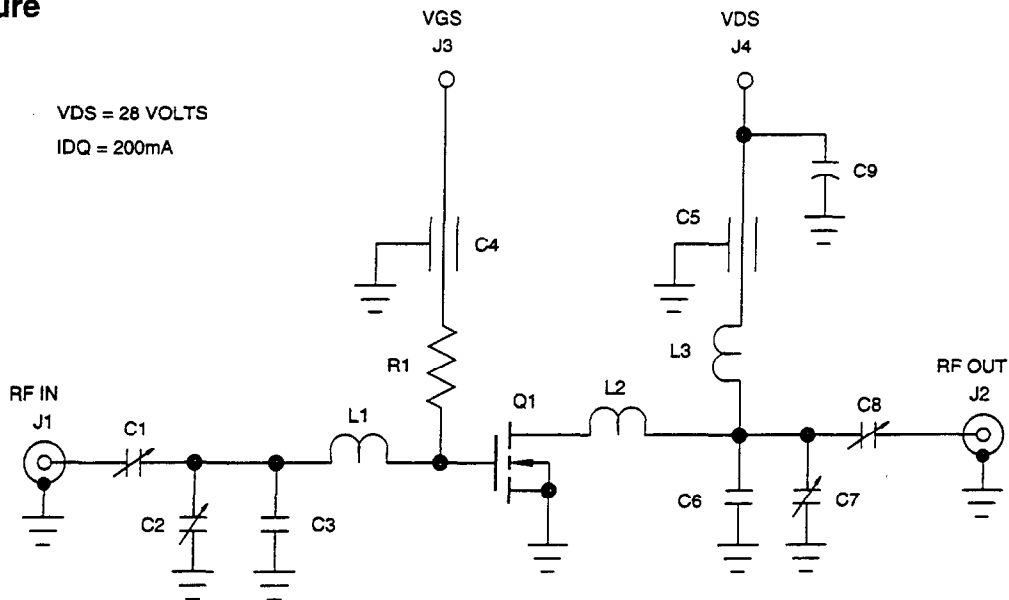

PARTS LIST

C1,C7,C8	TRIMMER CAPACITOR 4-40pF
C2	TRIMMER CAPACITOR 9-180pF
C3,C6	CAPACITOR 50pF
C4,C5	FEEDTHROUGH CAPACITOR 0.004uF
C9	ELECTROLYTIC CAPACITOR 50uF 50 VOLT
L1	NO. 12 AWG COPPER WIRE X 1.25"
L2	NO. 12 AWG COPPER WIRE X 1.50"
L3	8 TURNS OF NO. 22 AWG ENAMEL WIRE ON '0.25", CLOSE WOUND
R1	RESISTOR 100K OHMS
Q1	DU2840S
BOARD	FR4 0.062"

Specifications Subject to Change Without Notice.

M/A-COM, Inc.

North America: Tel. (800) 366-2266
Fax (800) 618-8883

Asia/Pacific: Tel. +81 (03) 3226-1671
Fax +81 (03) 3226-1451

Europe: Tel. +44 (1344) 869 595
Fax +44 (1344) 300 020